

Dolcesguardo

design ver_lab

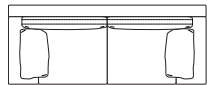

255 (100,4")

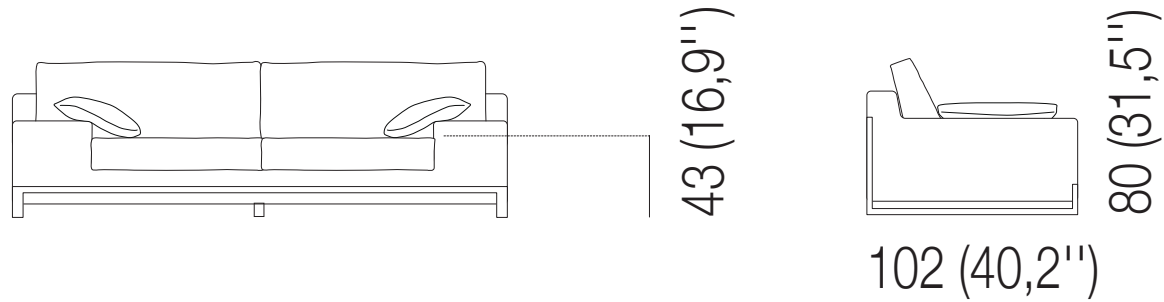
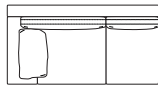

195 (76,8")

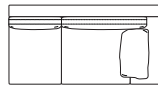

195 (76,8")

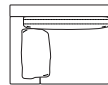

128 (50,4")

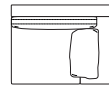

128 (50,4")

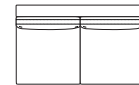

165 (65")



83 (32,7")

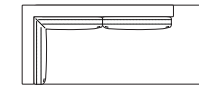

245 (96,5")

102 (40,2")

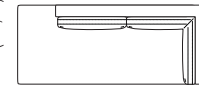

245 (96,5")

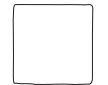

102 (40,2")

102 (40,2")

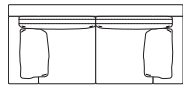

225 (88,6")

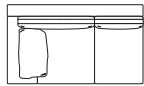

175 (68,9")

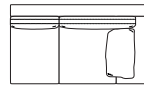

175 (68,9")

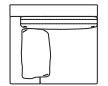

113 (44,5")

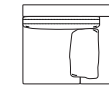

113 (44,5")

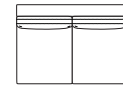

145 (57,1")

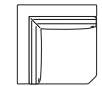

104 (40,9")

104 (40,9")

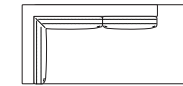

225 (88,6")

102 (40,2")

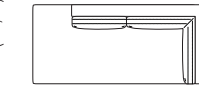

225 (88,6")

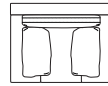

143 (56,3")

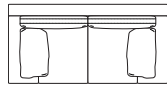

205 (80,7")

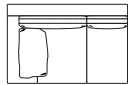

155 (61")

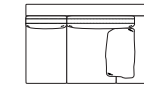

155 (61")

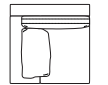

103 (40,6")

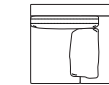

103 (40,6")

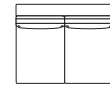

125 (49,2")

102 (40,2")

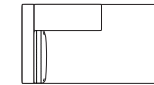

185 (72,8")

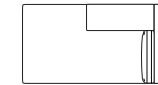

185 (72,8")

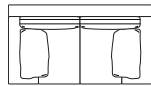

185 (72,8")



93 (36,6")

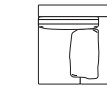

93 (36,6")

VERDESIGN

hand MADE
IN ITALY
www.verdesign.it

verdesign s.r.l.
via Pordenone 57, 33070, Brugnera, Pn - Italia
c.f. / p.iva 01708000938, rea PN98144
tel/fax +39.0434.627503 - info@verdesign.it

Dolcesguardo tech brief

| | | | | | |
|--------------------------------------|--|---|--|---|--|
| 1. Struttura | Legno di abete, multistrato di pino, fibra di legno, colla vinilica e con totale assenza di formaldeide. Molleggio con cinghie elastiche rinforzate e incrociate. | 1. Structure | Solid fir wood, poplar plywood, wood fiber, vinyl glue and formaldehyde-free. Suspensions with crossed and reinforced elastic belts. | 1. Structure | Sapin massif, panneau multicouche de peuplier, fibre de bois, colle vinylique et avec totale absence de formaldéhyde. Suspension avec des sangles élastiques renforcées et entrecroisées. |
| 2. Imbottiture | Struttura in poliuretano espanso a densità differenziata rivestito da fodera in vellutino bianco accoppiato a fibra di poliestere. Cuscini di seduta e di schienale in poliuretano espanso con rivestimento esterno in misto piuma d'oca bianca sterilizzata (50%) e fibra di poliestere, con compartimentazione interna. Cuscinetto laterale in misto di piuma d'oca bianca sterilizzata (50%) e fibra di poliestere, con compartimentazione interna. | 2. Padding | Structure in polyurethane foam with differentiated density, covered by a white fabric lining joined with polyester fiber. Seat and back cushions in polyurethane foam and covering with a mix of white goose sterilized feathers (50%) and polyester fiber, with internal partitioning. Side pillow with a mix of white goose sterilized feathers (50%) and polyester fiber, with internal partitioning. | 2. Rembourrage | Structure en mousse de polyuréthane à densité différenciée, revetu par une doublure de tissu blanc accouplé au fibre de polyester. Coussins d'assise et de dos en mousse de polyuréthane avec revêtement extérieur en mixte de plume d'oie blanche stérilisée (50%) et fibre de polyester, avec partitionnement interne. Coussin latéral en mixte de plume d'oie blanche stérilisée (50%) et fibre de polyester, avec partitionnement interne. |
| 3. Cuciture | In filo di poliestere ad elevata resistenza, realizzate di serie nello stesso tono del rivestimento. Possibile realizzazione con toni diversi, senza sovrapprezzo. | 3. Stitching | In high resistance polyester thread, as a standard manufactured in the same shade of the cover. Different shades are possible, without surcharge. | 3. Coutures | En fil de polyester à haute résistance, fabriqué en standard dans le même ton du revêtement. Possible réalisation avec des tons de couleur différents, sans surtaxe. |
| 4. Rivestimenti | Struttura non sfoderabile. Cuscinetto laterale sfoderabile. Cuscini di seduta e di schienale sfoderabili e con tessuto jacquard antiscivolo. Fondo del divano in tessuto jacquard non sfoderabile. | 4. Covers | Not removable structure. Removable side pillow. Removable seat and back cushions and with anti-slip jacquard fabric. Underneath of the sofa with not removable jacquard fabric. | 4. Housses | Structure pas déhoussable. Coussin latéral déhoussable. Coussins d'assise et de dos déhoussables et avec du tissu jacquard antiglisse. Bas du canapé en tissu jacquard pas déhoussable. |
| 5. Resistenza al fuoco | Tutte le gomme, le piume e le fibre impiegate sono esclusivamente ignifughe. | 5. Fire resistance | All used foams, feathers and fibers are exclusively fireproof. | 5. Résistance au feu | Toutes les mousses, les plumes et les fibres utilisées sont uniquement ignifuges. |
| 6. Sistema di unione elementi | Meccanismo di giunzione in metallo a bloccaggio progressivo. Applicato sul fondo di ogni coppia di elementi in posizione laterale e a scomparsa. | 6. Modular elements joining system | Metal joining mechanism with gradual locking. Set in the underneath of each couple of elements, in lateral and retractable position. | 6. Système d'union des éléments modulaires | Mécanisme de jonction en métal à blocage progressif. Appliqué sur le fond de chaque couple d'éléments, en position latérale et rentrant. |
| 7. Piedi | Legno massello di noce nero ("canaletto"), premontato e con feltrini antigraffio. Finitura con vernici all'acqua con effetti "soft touch", "anti reflex" e "anti fingerprint". | 7. Feet | Solid black walnut wood ("canaletto"), pre assembled with scratchproof felts. Water based coatings with "soft touch", "anti reflex" and "anti fingerprint" effects. | 7. Pieds | Bois massif de noyer noir ("canaletto"), prémonté et avec feutres anti-rayures. Finition avec peintures à base d'eau avec effets "soft touch", "anti reflex" et "anti fingerprint". |
| 8. Imballo | Sacco in polietilene, nylon a bolle d'aria e scatola in cartone rinforzato. Adatto per trasporto terrestre, marittimo e aereo. | 8. Packaging | Polyethylene bag, bubble nylon and reinforced cardboard box. Suitable for land, sea and air freight. | 8. Emballage | Sac en polyéthylène, nylon à bulles et boîte de carton renforcé. Approprié pour transport terrestre, maritime et aérien. |

